



The Future of Water

SALT CHLORINE GENERATOR

- **TROUBLESHOOTING GUIDE**
- **TECHNICAL SUPPORT MANUAL**

SALT CHLORINE GENERATOR TROUBLESHOOTING AND ERROR DIAGNOSIS

TABLE OF CONTENTS

- [CHEMISTRY AND SALT REQUIREMENTS, SALT ADDITION TABLE](#)
- [CELL CLEANING](#)
- [SYSTEM ERROR CODE DIAGNOSIS](#)
- [SYSTEM ERROR 1](#)
- [SYSTEM ERROR 2](#)
- [SYSTEM ERROR 3](#)
- [SYSTEM ERROR 4, 5, 6, 7](#)
- [PSU FAIL / NO LIGHTS, ACTIVITY ON PSU](#)
- [WATER FLOW ERROR LIGHT](#)
- [CHECK CELL LIGHT SOLID](#)
- [TECH MODE ON - BOARD DIAGNOSTICS](#)
- [TECH MODE – CHECK AMPS](#)
- [TECH MODE – CHECK VOLTS](#)
- [CHECK CELL LIGHT FLASHING](#)
- [LOW SALT LIGHT FLASHING](#)
- [SYSTEM NOT PRODUCING](#)
- [BUCKET TEST](#)
- [REPROGRAMMING](#)

CHEMISTRY AND SALT REQUIREMENTS, SALT ADDITION TABLE

- The Salt Generating System is designed to operate efficiently with a salt level maintained between 3500 and 4500 ppm. Depending on pool size, when additional salt is added, it may take as much as 24 hours for salt to adequately dissolve.
- Acceptable salt is Granulated Pool Salt. *DO NOT USE: iodized salt, salt with greater than 1% anti-caking agents, rock salt, water softener salt, calcium chloride (not salt). Use SODIUM CHLORIDE ONLY.*
- The chart at right indicates how much salt is required based on the volume of the pool and the current salt level.
- OPTIMAL RANGES FOR POOL CHEMISTRY** (NECESSARY TO ALLOW CHLORINE PRODUCTION TO BE EFFECTIVE IN WATER SANITATION):

Free chlorine 2 - 4 ppm

Salt Level 3500 - 4500ppm

pH 7.2 – 7.6ppm

Total Alkalinity 80 – 120ppm

Cyanuric Acid (Stabilizer) 60 – 80ppm

Total Dissolved Solids 0 - 1500ppm (after subtracting the salt level)

Calcium Hardness 200 - 350ppm

Phosphates 0ppm

Nitrates 0ppm

	Salt level before addition (in PPM)								
	0	500	1000	1500	2000	2500	3000	3500	4500
	How much salt to add (in pounds)								
4	117	100	83	67	50	33	17	0	OK
6	175	150	125	100	75	50	25	0	OK
8	234	200	167	133	100	67	33	0	OK
10	292	250	209	167	125	83	42	0	OK
12	350	300	250	200	150	100	50	0	OK
14	409	350	292	234	175	117	58	0	OK
16	467	400	334	267	200	133	67	0	OK
18	525	450	375	300	225	150	75	0	OK
20	584	500	417	334	250	167	83	0	OK
22	642	550	459	367	275	183	92	0	OK
24	701	600	500	400	300	200	100	0	OK
26	759	651	542	434	325	217	108	0	OK
28	817	701	584	467	350	234	117	0	OK
30	876	751	626	500	375	250	125	0	OK
32	934	801	667	534	400	267	133	0	OK
34	992	851	709	567	425	284	142	0	OK
36	1051	901	751	600	450	300	150	0	OK
38	1109	951	792	634	475	317	158	0	OK
40	1168	1001	834	667	500	334	167	0	OK
42	1226	1051	876	701	525	350	175	0	OK
44	1284	1101	917	734	550	367	183	0	OK
46	1343	1151	959	767	575	384	192	0	OK
48	1401	1201	1001	801	600	400	200	0	OK
50	1460	1251	1043	834	626	417	209	0	OK

From a connected device, click the table above to be redirected to Pool Chemical Calculator, an online pool chemistry resource with an interactive salt calculator

CELL CLEANING

- In addition to maintaining proper water chemistry, it is necessary to clean the salt cell as part of regular system operation.
- Recommended cleaning schedule is typically every 3-4 months of operation or whenever the cell appears to have significant calcium or other debris build-up. The cell should be monitored monthly to make sure calcium buildup is properly addressed.
- Depending on the water quality and hardness, some systems will have to be cleaned more often.
- **CAUTION: Do not use metal or other hard objects to clean the cell. Do not insert anything into the cell. Both of these actions could scratch the precious metal coating on the plates and void the warranty.**
- Cell Cleaning can be performed with either white vinegar or a solution of water and muriatic acid. If using acid, **ALWAYS ADD ACID TO WATER, NOT WATER TO ACID.** DILUTED MURIATIC ACID SOLUTION = 1 PART ACID TO 4 PARTS WATER. **NOTE: FOLLOW THE INSTRUCTIONS OF THE ACID MANUFACTURER.**

1. Remove the cell from the line by unthreading the barrel unions from the cell ends. There is no need to remove the electrical wire connections when using the cleaning cap.
2. Remove the black O-ring on one end of the cell.
3. Attach the cleaning cap to the other end of the cell.
4. Pour the cleaning solution into the cell.
5. Wait for foaming to stop, approximately 5-10 minutes with acid; vinegar takes longer. If using acid, do not leave the cell soaking more than 10 minutes; if foaming continues, rinse and repeat the process to this point.
6. Safely dispose of the acid solution by pouring into the pool.
7. Rinse the cell with a water hose.
8. Put the O-ring back in place and re-install the cell to the line.

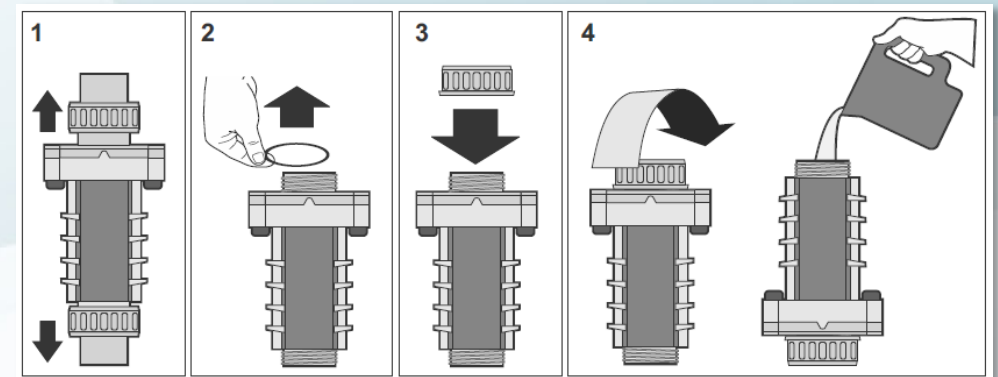

SYSTEM ERROR CODE DIAGNOSIS

- When the System Error indicator light is illuminated, the following diagnostic is performed to identify the System Error code.
- **SYSTEM ERROR LIGHT MUST BE ILLUMINATED TO BEGIN THE TESTING.**
- If System Error light is lit, to get the correct error code, the ON/OFF Button light **MUST BE OFF.**
- If the ON/OFF Button light is ON, then tap the ON/OFF Button once.
- The ON/OFF light will go OFF, and the System Error light will remain ON with the number of stacked LED lights above the CL2 Button corresponding to the System Error code.
- How many LED lights are lit on the CL2 indicator? This is the System Error currently indicated. Proceed to the corresponding section for that System Error code. In the example, System Error code 1 is shown.

Critical System errors (2, 4, 5, 6, 7) may result in automatic shut-down of the PSU. In these cases, the ON/OFF indicator will already be off, System Error light on, and the corresponding number of LED lights shown on the output indicator. If the PSU is turned back on, it will continue to shut off and return to the System Error state, showing the number of LED lights that correspond with the specific error code.

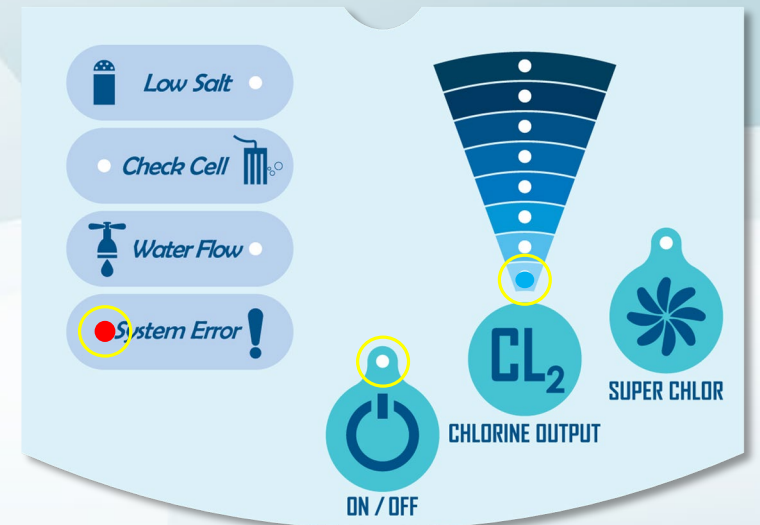

SYSTEM ERROR 1 NO/LOW SALT OR CONNECTION PROBLEM

- Check salt level and adjust to minimum 3500ppm.
- Confirm [cell is clean](#) or has been recently cleaned.
- Check for air getting pulled into the cell causing large bubbles.
- Check cell blades.

If they are damaged, deteriorated, or pitted, replace the cell.

- Check all connections and clean if necessary to remove any corrosion or debris.

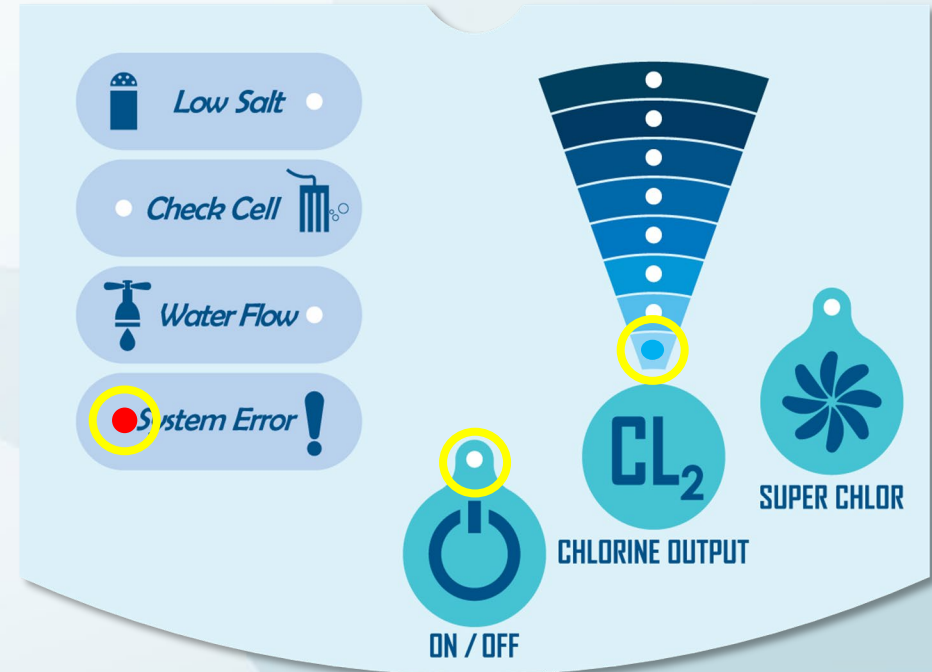

If none of the above resolve the System Error 1, proceed with the further troubleshooting on the next page to determine the second numerical error code for the System Error one. (Example: System Error 1.1, System Error 1.2, and so on).

SYSTEM ERROR 1 DIAGNOSTICS ARE DIFFERENT FOR PSU'S WITH SERIAL NUMBERS ENDING K24 OR LATER. PLEASE SEE THE INSTRUCTIONS ON PAGE 8 FOR THE UPDATED DIAGNOSTIC STEPS.

SYSTEM ERROR 1 - CONTINUED

- **Disconnect cell connections from power supply and connect the white and black connections from the power supply together to bypass the cell, as shown. Leave the connections from either side of the cell disconnected.**
- **Turn back on pump and the Salt Generating System. The System Error indicator light should come on within a few moments. Once the System Error light is on again, take note of the number of LED indicator lights lit above the CL2 button. This corresponds to the second part of the System Error 1 code. Once the second part of the System Error code is determined, do not leave the connections to power supply together for too long, it could damage the power supply.**
- **If the result is error code 2? The complete System Error code is 1.2. Cell needs replacement.**
- **If the result is anything other than error code 2 (System Error 1.1, 1.3, 1.4, etc.)? Replace the power supply.**
- **To protect the other connections until replacement part arrives connect cell and power supply back together correctly.**



NOTICE FOR PSU SERIAL NUMBERS 'K24' AND LATER:
[System Error 1 diagnostics are different for PSU's with serial numbers ending K24 or later. Please see the instructions on the next page which cover the updated diagnostic steps.](#)

SYSTEM ERROR 1

FOR PSU SERIAL NUMBERS ENDING 'K24' OR LATER

- Follow the instructions from page 5 to determine that the system error is a system error 1.
- Verify that the cell has been cleaned and the salt level is between 3500-4500ppm.
- Disconnect the cell to PSU Connectors. Leave the cell ends disconnected, and connect the PSU to itself.
- Turn the PSU back on with the ON/OFF Button.
- **WAIT 45 SECONDS**
- If the Unit flashes all lights and Reboots, the PSU is functional, and the cell needs to be replaced.
- If the unit does not flash all lights and goes directly to System Error light, there is a PSU failure.



SYSTEM ERROR 2 OVER CURRENT OR DEBRIS STUCK IN BLADES

- Turn off pump and the Salt Generating System.
- Check cell blades for any debris or foreign object lodged between blades. Make sure not to stick anything in between the blades to get it out. Use a high-pressure hose to clean out debris.
- Check cell blades. If they are damaged, deteriorated, or pitted, replace the cell.
- Check all connections and clean if necessary. [Clean the cell](#) if it has not been cleaned.
- If none of the above resolve the System Error 2, proceed to the next stage of troubleshooting the error code, described on the following page.

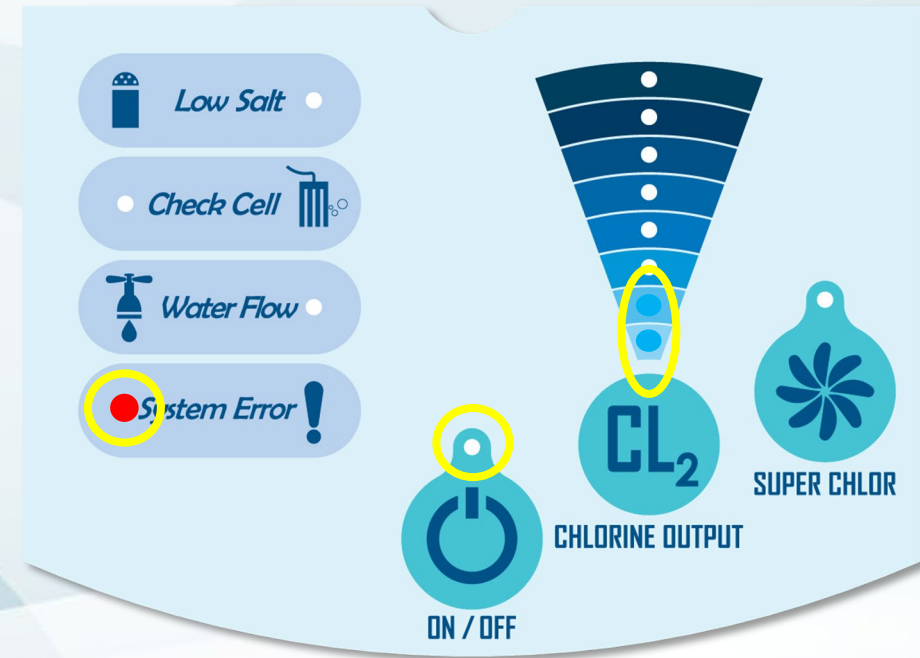

SYSTEM ERROR 2 - CONTINUED



- **Disconnect one end of the cell and power supply connections, so only one side of the connection from PSU to cell is connected and one side disconnected.**
- **Turn back on pump and the Salt Generating System. The System Error indicator light should come on after a few moments. Once the System Error light is on again, take note of the number of LED indicator lights lit above the CL2 button. This corresponds to the second part of the System Error 2 code. *Do not leave the connections to power supply connected only at one side for long after the system error comes back on, it could damage the power supply.***
- **If the subsequent error code is 1, the complete System Error is 2.1 – Replace the cell.**
- **If the subsequent error code is 2, the complete System Error is 2.2 – Replace the PSU.**
- **To protect the other connections until the replacement part arrives connect cell and power supply back together correctly.**

SYSTEM ERROR 3 TEMP SENSOR CONNECTIONS

Check temperature sensor connection to make sure the wire is not broken or loose and connections are free of corrosion; clean if necessary. The temperature sensor is located on the T-pipe, usually placed ahead of the cell, which has the flow sensor unit on top of the pipe. The temperature sensor is a silver nut screwed into the pipe

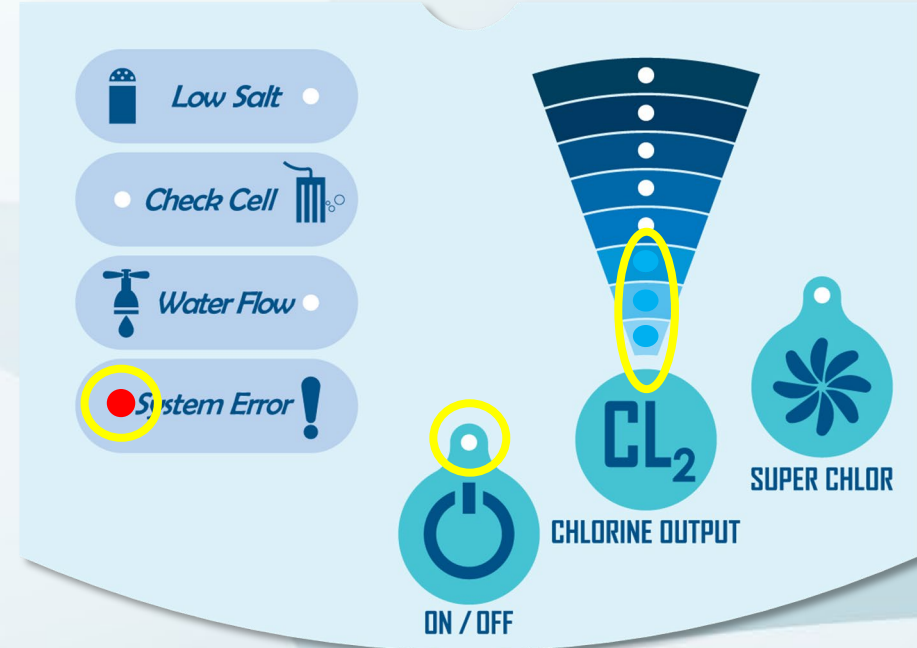
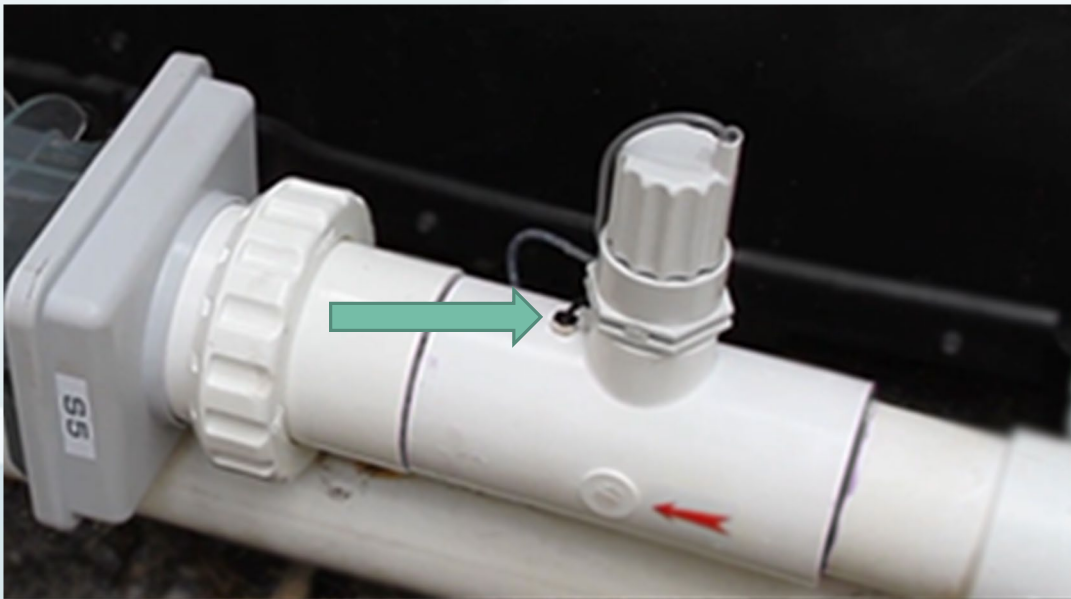

If there is no visible damage to the temp sensor or the connections, and cleaning any corrosion does not resolve the issue, proceed to the secondary troubleshooting on the following page.

SYSTEM ERROR 3 - CONTINUED

- **NEED A SMALL METAL WIRE OR SIMILAR OBJECT, SUCH AS A PAPERCLIP, TO TOUCH MALE PINS TO COMPLETE THE CIRCUIT**
- **Disconnect the temp sensors.**
- **Tap the CL2 Button on the Power Supply Unit until all 8 LEDs are on.**
- **Wait to allow the system to ramp up (about 45 seconds).**
- **Press and hold SuperChlor Button for about three seconds until the water flow light comes on.**
- **Tap the CL2 Button twice get to check cell light.**
- **At this point there should be 7 CL2 LED Lights lit.**
- **Touch the jumper wires (paper clip or other metal to complete the circuit) to the male prongs on the connector.**
- **With the jumper securely touching both prongs, the 7 CL2 lights should jump to 8 CL2 lights on the chlorine output scale.**
- **If 7 CL2 lights show without the jumper and 8 CL2 lights with jumper – temp sensor failure.**
- **Note if the connectors are flat or round for replacement. If flat connectors will need the transition wires to connect to the round connectors (GNR00012).**
- **If 7 CL2 lights are lit without jumper and 7 CL2 lights with jumper – Power Supply Unit failure.**
- **(If the connections are flat try re-crimping the connectors first).**



SYSTEM ERROR 4, 5, 6, 7 – CRITICAL FAULT

- **SYSTEM ERROR CODES 4-7 INDICATE A CRITICAL FAULT IN THE PSU AND WILL REQUIRE IT TO BE REPLACED.**
- **DO NOT ATTEMPT TO OPEN THE PSU (WALL MOUNTED CONTROL UNIT).**
- **PSU IS NOT FIELD SERVICABLE AND THIS WILL VOID THE WARRANTY.**

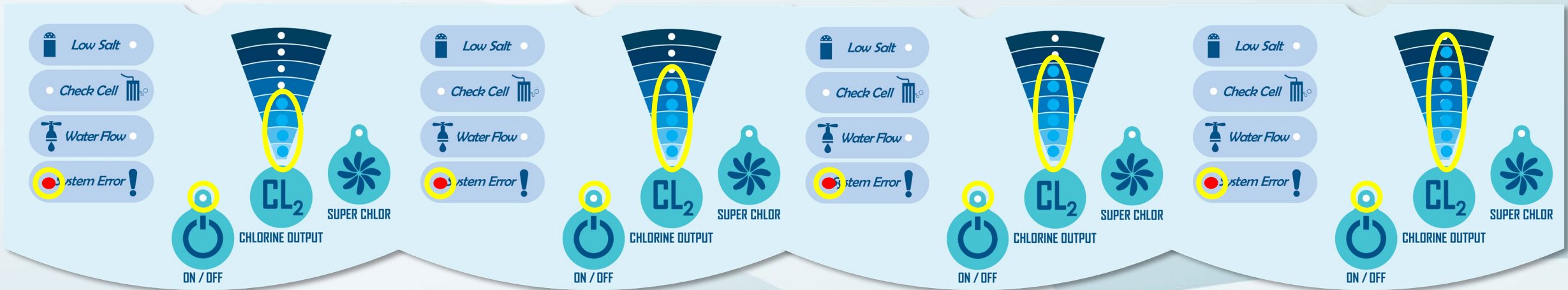

NON-FUNCTIONAL PSU / No Power on Display Board:

- Is the pump running?
- Are all the breakers on?
- Is there power going to the unit?

If all above are confirmed and there is power but the system is not powering on or reacting, the PSU will need to be replaced.

WATER FLOW ERROR LIGHT

- (WILL NEED A SMALL METAL WIRE OR SIMILAR OBJECT, SUCH AS A PAPERCLIP, TO TOUCH FEMALE PIN HOLES TO COMPLETE THE CIRCUIT)
- **Confirm the water flow sensor is connected, and the wire is not broken or loose.**
- **Turn the pump and the Salt Generating System off.**
- **Unscrew the flow switch to make sure the paddle is moving back and forth correctly.**
- **Does the paddle have adequate range of motion and tension to return ('snap back') to the start position automatically? Is the paddle stuck or broken?**
- **If stuck, broken or the paddle has no tension, the flow switch will need to be replaced. (Note if the connectors are flat or round for replacement. If flat connectors will need the transition wire part [GNR00012] to connect to the round connectors).**
- **Reconnect flow switch into T-pipe with the arrow on top of the flow switch matching the arrow on the T-pipe (pointing in the direction of return flow to the pool).**
- **If there is no indication the flow switch is broken or the connections damaged, proceed to the next section of water flow light diagnostic testing on the following page.**

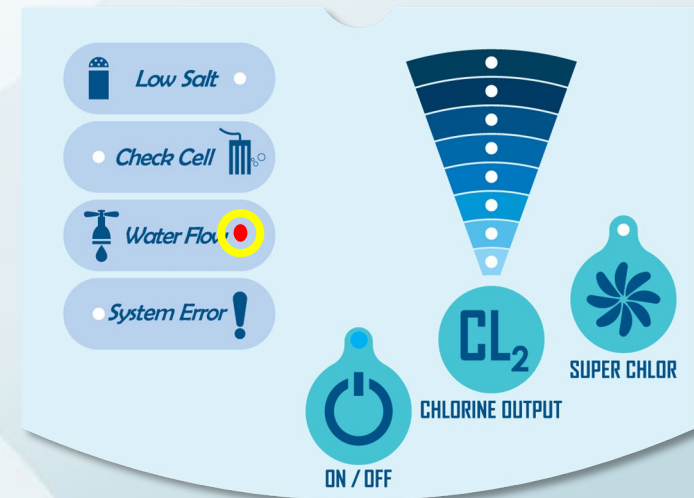

WATER FLOW ERROR LIGHT - CONTINUED

- **Disconnect the flow switch connection cord from the Power Supply Unit.**
- **Put the small jumper wire in the female connector pin holes in the Power Supply Unit side of the connections. Make sure the wire is in both sides of the female connections and secure, to complete the circuit.**

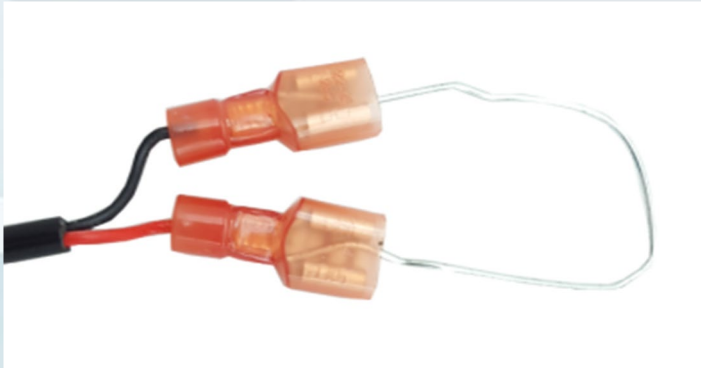

- **Turn on the pump and the Salt Generating System and see if the light goes off.**
- **If the water flow light does not go off - Replace the power supply.
(If the connections are flat try re-crimping the connectors first)**
- **If the light goes off - Replace the flow switch
(Note if the connectors are flat or round for replacement).**



CHECK CELL LIGHT SOLID

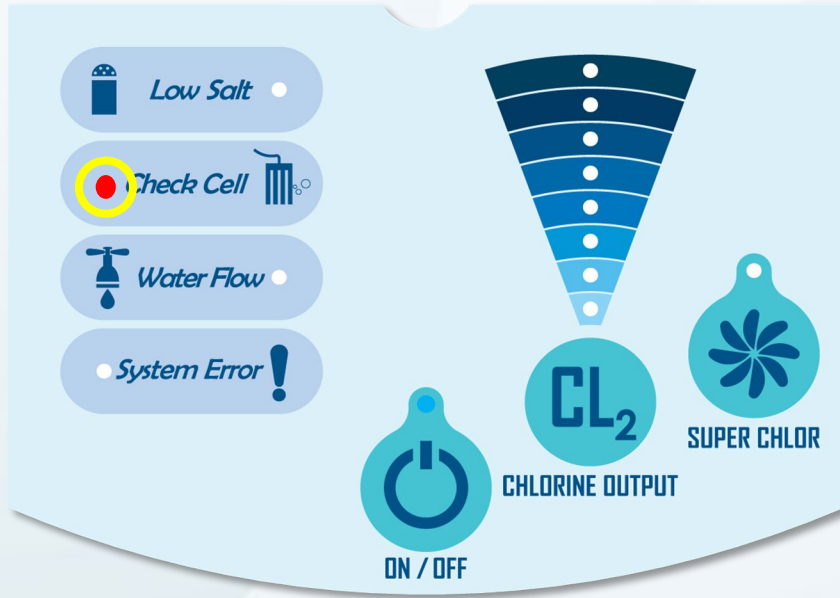

Solid Check Cell light indicates:

- I) **Critical salt level - Check current salt level. Critically low/high salt level will trigger the solid check cell light. Salt should be between 3500 and 4500ppm.**
- II) **Cell needs cleaning - Clean the calcium build up. Soak in 1 part muriatic acid and 4 parts water until foaming stops. This typically takes about 5 to 10 minutes; if foaming persists, rinse and repeat. Might need to do it 2 or 3 times depending on the buildup.**
- III) **Damage to blades. - Is there anything stuck in between the blades? Make sure not to stick anything in between the blades to get it out. Use a high-pressure hose to clean out debris. Check blades for damaged, broken or deteriorated blades.**
- IV) **Cell came to end of its useable life – Use Tech Mode procedure, described on the following page, to confirm. If cell reaches end of useable life naturally less than 2 years old, the system goes into the limited portion of the warranty and the cell gets a 40% discount from the MSRP pricing.**

- Is the pool losing prime causing air in the cell?
- If the cell has a white, milky coating and no longer clear, the cell is heating up without water. If the pump goes off and the Salt Generating System remains on, water flow sensor failure should be checked.
- When putting a new cell on, can show a check cell solid. The system calibrates every 40 minutes. When it completes calibration the check cell will go off.

TECH MODE ON-BOARD DIAGNOSTICS

Onboard Diagnostics to Determine the Health of the Cell

ACCESSING TECH MODE:

- The Salt Generating System, pool pump and pool system should be on and operating normally.
- Tap the CL2 Button until all 8 LEDs are on.
- Wait to allow the system to ramp up (about 45 seconds) and then PRESS AND HOLD SuperChlor Button for about 3-5 seconds UNTIL the Water Flow light comes on. In each test indicated in the next sections, the LED lights above CL2 Button will alternate back and forth between two values. One value of indicator lights will be lit simultaneously with the ON/OFF LED light ON. The second value is indicated by the number of LED CL2 indicator lights lit when the ON/OFF LED light is OFF.



TECH MODE – CHECK AMPS

- Once Tech Mode is engaged, Water Flow light should be ON, On/OFF light should be flashing and CL2 output indicator should alternate between two values.
- How many LED lights are lit with ON/OFF LED **ON** and how many are lit with the ON/OFF LED **OFF**?

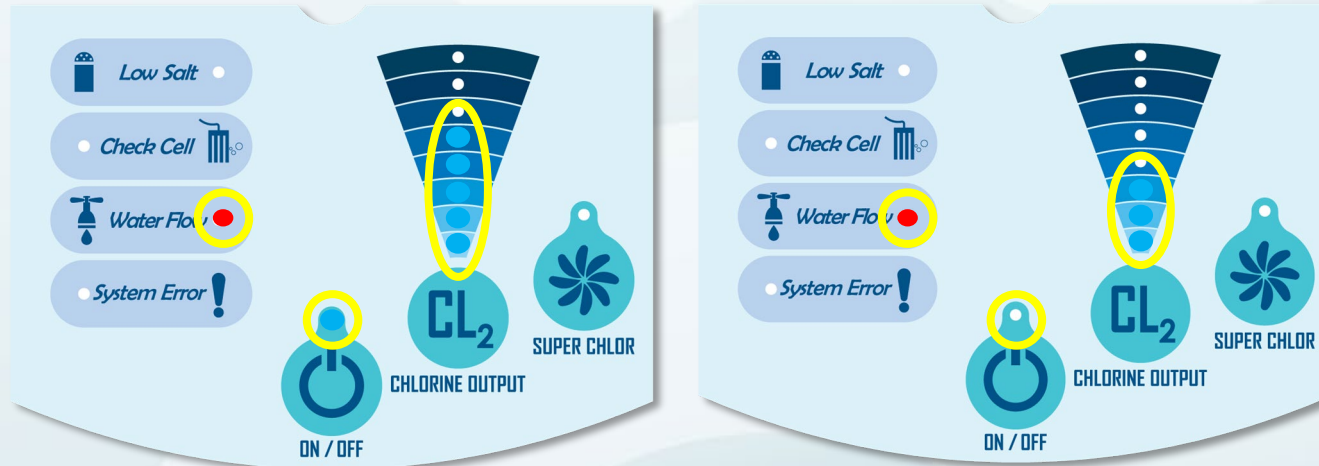

Example shows 5 lights LIT with ON/OFF LED ON and 3 lights LIT with ON/OFF LED light OFF; tech mode reporting 5.3 amps

If a number greater than 8 is reported, the SuperChlor button LED light serves as the additional, 9th, LED indicator. Generally this is reserved for the Temperature and Hours reporting

- Optimal ranges for amps are between 5.8 and 6.0.
- Anything less than 5.8 amps, with the salt level confirmed adequate and the cell cleaned, indicates the cell has come to the end of its useable life or the blades are damaged.
- To move on to the next Tech Mode section once amps are documented, click CL2 once.

TECH MODE – CHECK VOLTS

- Check volts by tapping the CL2 Button once when in the Tech Mode Amps section, and the Low Salt light will come on. The LED lights above CL2 Button will alternate back and forth with the ON/OFF LED light.
- How many LED lights are lit with ON/OFF LED **ON** and how many are lit with the ON/OFF LED **OFF**?

Volt levels are based on 3,500 ppm of salt. If salt is low volts are higher than range and if salt is high volts are lower than range

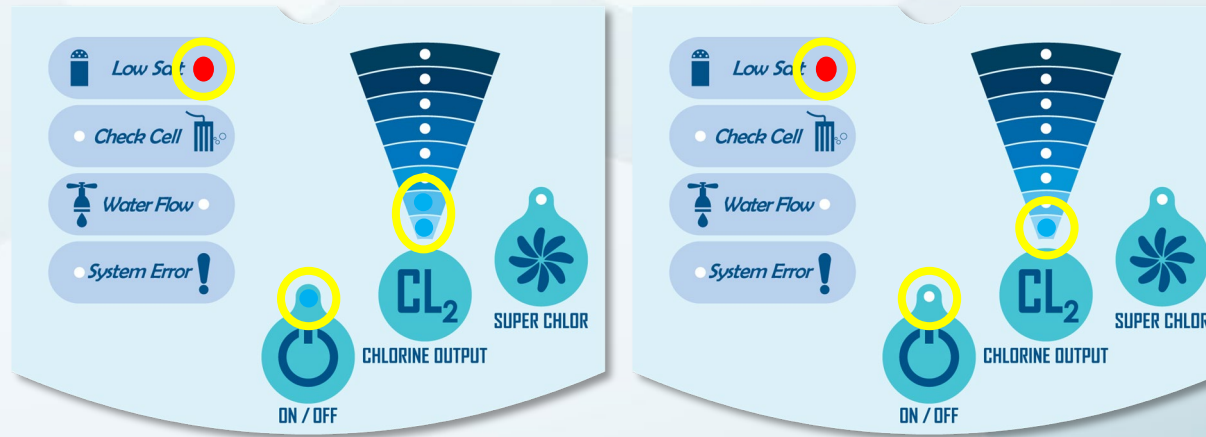

13-14 volts good for 15K

18-20 volts good for 25K

25-27 volts good for 40K

- **Example shows 2 CL2 LED lights LIT with the ON/OFF light ON and 1 LED CL2 light LIT with the ON/OFF light OFF – indicating 21 Volts**
- Low Voltage means the salt level is high, or something is stuck in between the cell blades.
- High Voltage means the salt level is low, the [cell needs to be cleaned](#), has a connection issue, or needs replacement.

TECH MODE – CONTINUED CHECK TEMPERATURE IN CELSIUS DEGREES

- Check temperature in Celsius Degrees by pressing CL2 once from the Tech Mode Volts section and the Check Cell light will come on.
- How many LED lights are lit with ON/OFF LED ON and how many are lit with the ON/OFF LED OFF?

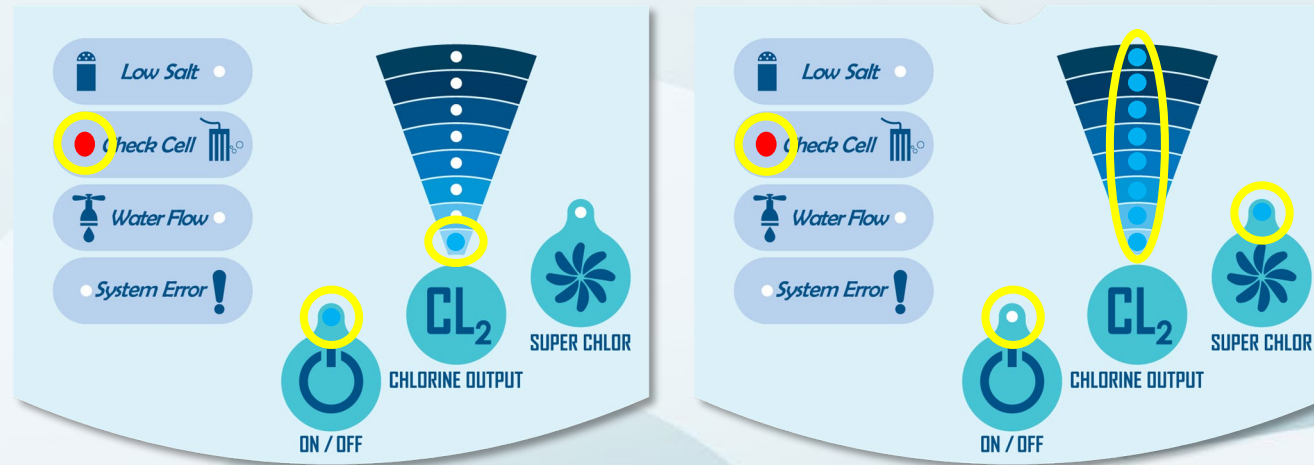

- Example shows 1 CL2 LED light LIT with the ON/OFF light ON and 8 LED CL2 lights, plus the SuperChlor button LED light LIT with the ON/OFF light OFF – These two values combined indicate a total of 19 degrees Celsius.
- If a number greater than 8 is reported, the SuperChlor button LED light serves as the additional, 9th, LED indicator. Generally this is reserved for the Temperature and Hours reporting.

TECH MODE – CONTINUED CHECK PRODUCTION HOURS

- Press CL2 Button once from the Tech Mode Temperature section to get to System Error indicator light
- How many LED lights are lit with ON/OFF LED **ON** and how many are lit with the ON/OFF LED **OFF**?

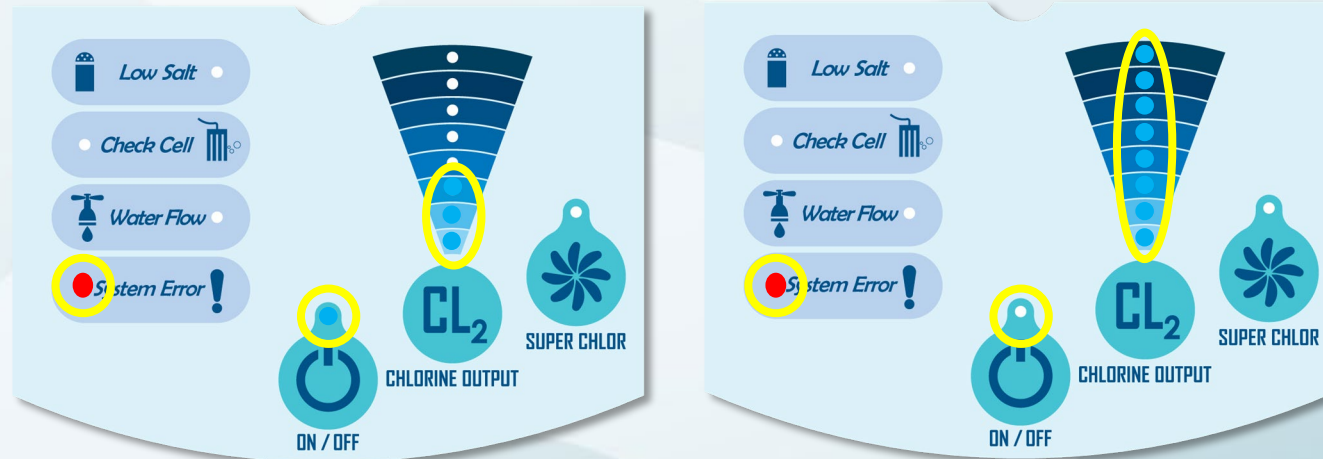

- **The example shown indicates 3800 hours of output for the unit, with 3 CL2 LED lights lit when the ON/OFF light is ON and 8 CL2 LED lights lit when the ON/OFF light is OFF.**
- If at any point the ON/OFF light stops flashing, the Tech Mode menu has timed out, and will need to be restarted by holding SuperChlor. From here it is possible to click CL2 to move through any sections already completed until reaching the desired section.

CHECK CELL LIGHT FLASHING

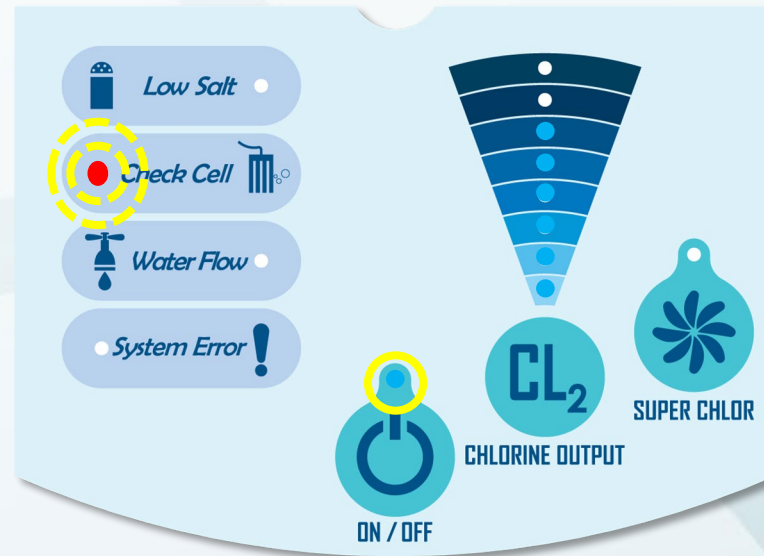

Check Cell Light Flashing is a timed warning that the cell has been running for 8,000 hours. This serves as a reminder to [clean the cell](#) if it has not been cleaned recently. At this point, it is advisable to check amps and volts using the [Tech Mode](#) procedure reviewed on the previous pages. If the amps and volts are in range, the cell is functional to continue operation. The PSU will need to be [reprogrammed](#) to clear the flashing check cell indicator.

LOW SALT LIGHT FLASHING

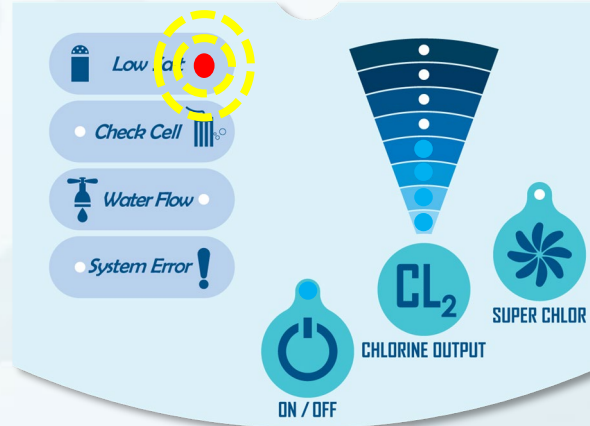

Low Salt Light Flashing means:

- Salt level is getting critically low. Check and adjust salt to 3500-4500ppm.
- The cell needs cleaning - [Clean the cell](#) by soaking the cell in 1 part muriatic acid and 4 parts water until foaming stops; about 5 to 10 minutes. Might need to do it 2 or 3 times depending on the buildup
- Cell blades have worn down due to usage and the cell is coming to the end of its useable life - Low Salt light flashing comes on when the blades have naturally worn down over time. Use the [Tech Mode](#) procedure to check the amps and volts. If amps are good and volts are high, then the blades are wearing down. This is a sign of an aging cell. If amps and volts are low, the cell has reached end of life and will need to be replaced to restore efficient operation of the system.
- The Power Supply is programmed to the wrong size for the cell. Need to check the programming. Use the [Reprogramming System](#) procedure to confirm the system is programmed correctly to the cell size.

SYSTEM NOT PRODUCING

- How many hours a day is the unit running and at what chlorine level? Systems closer to the size of the pool will need to operate at longer times and higher output level.
- Check salt levels and adjust to required level of 3500ppm-4500ppm.
- [Clean cell](#) from buildup. Soak in 1 part muriatic acid and 4 parts water until foaming stops. Generally takes about 5 to 10 minutes. Might need to do it 2 or 3 times depending on the buildup. Do not submerge the cell in the solution longer than 10 mins; rinse and repeat the process. Make sure to not stick anything in between the blades; use a high pressure hose to rinse after cleaning or remove any debris from the cell.
- Test the water chemistry. High pH, low stabilizer/ cyanuric acid, low salt and presence of phosphates and nitrates all play a major role in depletion of available chlorine. In many cases, systems are generating chlorine, but the chlorine being produced is absorbed by chemical imbalance in the water.
- Is the system losing prime? System will shut down to protect itself
- Use the [Tech Mode](#) procedure to verify the system is producing adequate amps and volts. If the amps and volts are in range, the system is operating properly and producing chlorine.

Required Chemistry Ranges for Optimal Production

Salt: 3500ppm-4500ppm, Free Chlorine: 1-3ppm, pH: 7.2-7.6 ppm, Alkalinity: 80 -120ppm, Cyanuric Acid: 50-80ppm, Phosphates: 0ppm, Nitrates: 0ppm, Calcium Hardness: 250-300ppm, TDS: less than 1500ppm (after subtracting salt level)

BUCKET TEST

Bucket Testing the Cell is an Alternative Test to Check Production

Bucket Testing can be performed with or without a bypass cell; testing the cell in bucket is more accurate than dripping water from the end of the cell on test strip.

BUCKET TEST **WITH** A BYPASS CELL:

- Fill 5 Gallon bucket or similar with pool water.
- Turn off Pump and the Salt Generating System.
- Remove the cell and place into the 5-gallon bucket full of pool water (salt should be 3500-4500 ppm in both pool and bucket).
- Leave the cell electrical connections connected to the Salt Generating System PSU.
- Install the bypass cell into the plumbing in place of the functional cell.
- Turn on just the Salt Generating System and pump and tap the CL2 Button until all 8 LED lights are lit.
- At this point, the system should be operating as normal. The pool system will continue to circulate and pool water will be passed through the bypass cell, however the functional cell in the bucket is connected to the Salt Generating System PSU and should begin to generate chlorine in the bucket. It takes a few minutes for the cell to ramp up. Let the cell bubble in the bucket and test the water for chlorine levels. If you have chlorine, it is producing, and something in the water is causing a high demand of chlorine.

BUCKET TEST **WITHOUT** A BYPASS CELL:

- Fill 5 Gallon bucket or similar with pool water.
- Turn off Pump and the Salt Generating System.
- Remove the cell and place into the 5-gallon bucket full of pool water (salt should be 3500-4500 ppm in both pool and bucket).
- Leave the cell electrical connections connected to the Salt Generating System PSU.
- Make sure the pool pump does not come on while the cell is removed from plumbing line. Remove the water flow switch and press the paddle forward so the Salt Generating System system will operate as if there is flow in the pipe.
- Turn on just the Salt Generating System and tap the CL2 Button until all 8 LED lights are lit.
- At this point, the system should be operating as normal. The pool system will continue to circulate and pool water will be passed through the bypass cell, however the functional cell in the bucket is connected to the Salt Generating System PSU and should begin to generate chlorine in the bucket. It takes a few minutes for the cell to ramp up. Let the cell bubble in the bucket and test the water for chlorine levels. If you have chlorine, it is producing, and something in the water is causing a high demand of chlorine.

REPROGRAMMING

Reprogramming is necessary:

- ✓ **Installing a new cell**
- ✓ **Clear the FLASHING check cell indicator**
- ✓ **Reset the programming of the PSU to match the cell size.**

If a larger cell is installed to a preexisting system, the system needs to be programmed to the correct size for the cell. If there is a discrepancy between the size indicated on the PSU and the cell, the system needs to be programmed to match the size indicated on the cell.

- Leave pump / pool system on.
- Manually turn off the Salt Generating System (press ON/OFF button).
- Press and hold down the CL2 until the LED output strip lights up. You will see either 1 light, 4 lights, or 8 lights. The PSU programming needs to be matched to the correct cell size. To get the size of system look on label on left side of power supply P/N: CLGX15A = 15K, CLGX25A = 25K and CLGX40A = 40K. The cell size is indicated on the cell: P/N: CLGX15A = 15K, CLGX25A = 25K and CLGX40A = 40K.
- Tap the CL2 Button twice to move the LED lights two positions and let it turn off. For example, starting on 1 LED indicator, tap CL2 twice, ends up on 8 LED lights. Starting on 4 LED lights, tap CL2 twice, ends on 1 LED light. Starting on 8 LED lights, tap CL2 twice, ends on 4 LED lights.
- Hold down the CL2 again until the LED lights back up and tap the CL2 once to get to the correct LED light setting quantity for the system and let the lights turn off. 1 light = 15K, 4 lights = 25K and 8 lights = 40K. To get the size of system look on label on left side P/N: CLGX15A = 15K, CLGX25A = 25K and CLGX40A = 40K. Or sticker on the bottom of the cell: P/N: CLGX15A = 15K, CLGX25A = 25K and CLGX40A = 40K.
- Manually turn on the Salt Generating System
- Turn off electrical from breaker; confirm The Salt Generating System powered off, leave off for about 30 seconds
- Turn back on electrical from breaker
- Turn on pump. Turn on the Salt Generating System
- Allow the system to run for at least 5 minutes to remember the setting before it shuts off

REPROGRAMMING FOR 15K CELL – CLGX15A

- **POOL SYSTEM AND PUMP SHOULD BE ON.**
- **MANUALLY TURN OFF THE SALT GENERATING SYSTEM.**
- **PRESS AND HOLD THE CL2 BUTTON UNTIL 1 LED LIGHT LIGHTS UP ON THE CHLORINE OUTPUT STRIP. WHEN PRESSING AND HOLDING CL2, WITH THE POWER OFF, IT CAN TAKE SEVERAL SECONDS FOR THE LIGHT TO COME ON.**
- **TAP THE CL2 BUTTON TWICE TO MOVE TO 8 LED LIGHTS AND LET THE UNIT SIT UNTIL THE LIGHTS TURN OFF**
- **HOLD DOWN THE CL2 AGAIN UNTIL 8 LED LIGHT COME BACK UP AND TAP THE CL2 ONCE TO GET BACK TO 1 LED LIGHT. LET THE UNIT SIT AGAIN UNTIL THE LIGHT FADES OFF.**
- **MANUALLY TURN ON THE SALT GENERATING SYSTEM**
- **TURN OFF ELECTRICAL FROM BREAKER; CONFIRM THE SALT GENERATING SYSTEM POWERED OFF, LEAVE OFF FOR ABOUT 30 SECONDS**
- **TURN BACK ON ELECTRICAL FROM BREAKER**
- **TURN ON PUMP**
- **TURN ON THE SALT GENERATING SYSTEM**
- **ALLOW THE SYSTEM TO RUN FOR AT LEAST 5 MINUTES TO REMEMBER THE SETTING BEFORE IT SHUTS OFF**

REPROGRAMMING FOR 25K CELL – CLGX25A

- **POOL SYSTEM AND PUMP SHOULD BE ON.**
- **MANUALLY TURN OFF THE SALT GENERATING SYSTEM.**
- **PRESS AND HOLD THE CL2 BUTTON UNTIL 4 LED LIGHTS LIGHT UP ON THE CHLORINE OUTPUT STRIP. WHEN PRESSING AND HOLDING CL2, WITH THE POWER OFF, IT CAN TAKE SEVERAL SECONDS FOR THE LIGHTS TO COME ON.**
- **TAP THE CL2 BUTTON TWICE TO MOVE TO 1 LED LIGHT AND LET THE UNIT SIT UNTIL THE LIGHT TURNS OFF**
- **HOLD DOWN THE CL2 AGAIN UNTIL 1 LED LIGHT COMES BACK UP AND TAP THE CL2 ONCE TO GET BACK 4 LED LIGHTS. LET THE UNIT SIT AGAIN UNTIL THE LIGHTS FADE OFF.**
- **MANUALLY TURN ON THE SALT GENERATING SYSTEM**
- **TURN OFF ELECTRICAL FROM BREAKER; CONFIRM THE SALT GENERATING SYSTEM POWERED OFF, LEAVE OFF FOR ABOUT 30 SECONDS**
- **TURN BACK ON ELECTRICAL FROM BREAKER**
- **TURN ON PUMP**
- **TURN ON THE SALT GENERATING SYSTEM**
- **ALLOW THE SYSTEM TO RUN FOR AT LEAST 5 MINUTES TO REMEMBER THE SETTING BEFORE IT SHUTS OFF**

REPROGRAMMING FOR 32K CELL – CLGX32A *ONLY SERIAL NUMBERS 'K24' OR LATER*

- **POOL SYSTEM AND PUMP SHOULD BE ON.**
- **MANUALLY TURN OFF THE SALT GENERATING SYSTEM.**
- **PRESS AND HOLD THE CL2 BUTTON UNTIL 6 LED LIGHTS LIGHT UP ON THE CHLORINE OUTPUT STRIP. WHEN PRESSING AND HOLDING CL2, WITH THE POWER OFF, IT CAN TAKE SEVERAL SECONDS FOR THE LIGHTS TO COME ON.**
- **TAP THE CL2 BUTTON TWICE TO MOVE TO 1 LED LIGHT AND LET THE UNIT SIT UNTIL THE LIGHT TURNS OFF**
- **HOLD DOWN THE CL2 AGAIN UNTIL 1 LED LIGHT COMES BACK UP AND TAP THE CL2 TWICE TO GET BACK 6 LED LIGHTS. LET THE UNIT SIT AGAIN UNTIL THE LIGHTS FADE OFF.**
- **MANUALLY TURN ON THE SALT GENERATING SYSTEM**
- **TURN OFF ELECTRICAL FROM BREAKER; CONFIRM THE SALT GENERATING SYSTEM POWERED OFF, LEAVE OFF FOR ABOUT 30 SECONDS**
- **TURN BACK ON ELECTRICAL FROM BREAKER**
- **TURN ON PUMP**
- **TURN ON THE SALT GENERATING SYSTEM**
- **ALLOW THE SYSTEM TO RUN FOR AT LEAST 5 MINUTES TO REMEMBER THE SETTING BEFORE IT SHUTS OFF**

REPROGRAMMING FOR 40K CELL – CLGX40A

- **POOL SYSTEM AND PUMP SHOULD BE ON.**
- **MANUALLY TURN OFF THE SALT GENERATING SYSTEM.**
- **PRESS AND HOLD THE CL2 BUTTON UNTIL 8 LED LIGHTS LIGHT UP ON THE CHLORINE OUTPUT STRIP. WHEN PRESSING AND HOLDING CL2, WITH THE POWER OFF, IT CAN TAKE SEVERAL SECONDS FOR THE LIGHTS TO COME ON.**
- **TAP THE CL2 BUTTON TWICE TO MOVE TO 4 LED LIGHTS AND LET THE UNIT SIT UNTIL THE LIGHTS TURN OFF**
- **HOLD DOWN THE CL2 AGAIN UNTIL 4 LED LIGHTS COME BACK UP AND TAP THE CL2 ONCE TO GET BACK 8 LED LIGHTS. LET THE UNIT SIT AGAIN UNTIL THE LIGHTS FADE OFF.**
- **MANUALLY TURN ON THE SALT GENERATING SYSTEM**
- **TURN OFF ELECTRICAL FROM BREAKER; CONFIRM THE SALT GENERATING SYSTEM POWERED OFF, LEAVE OFF FOR ABOUT 30 SECONDS**
- **TURN BACK ON ELECTRICAL FROM BREAKER**
- **TURN ON PUMP**
- **TURN ON THE SALT GENERATING SYSTEM**
- **ALLOW THE SYSTEM TO RUN FOR AT LEAST 5 MINUTES TO REMEMBER THE SETTING BEFORE IT SHUTS OFF**

WARRANTY CLAIM SUBMISSION

SHOULD THE SALT GENERATING SYSTEM SYSTEM REQUIRE A REPLACEMENT PART UNDER THE FULL COVERAGE PART OF THE WARRANTY PERIOD:

EXPEDITED SUBMISSION OF WARRANTY CLAIM PROCESSING REQUIRES THE FOLLOWING INFORMATION:

- MODEL NUMBER AND SERIAL NUMBER FROM THE POWER SUPPLY UNIT (LOCATED AT LEFT HAND SIDE ON PSU BOX, BARCODE STICKER AT TOP)
- SERIAL NUMBER FROM THE SALT CELL UNIT (BARCODE STICKER ON NECK)
- PROOF OF PURCHASE FOR THE SYSTEM.
- SHIPPING ADDRESS, IF NOT ALREADY INDICATED ON PROOF OF PURCHASE.
- BRIEF DESCRIPTION OF THE PROBLEM INCLUDING ANY DIAGNOSTICS OR SPECIFIC TROUBLESHOOTING AND RESULT.
- HOMEOWNER NAME OR OTHER DESCRIPTOR.

Technical Support is available from 9am - 5pm (EST) Mon-Fri
Call: 561-455-0252 email: support@solaxx.com